

TECEO GEN2



Designer : Michel Tortel



Lighting in an efficient and sustainable manner

TECEO GEN2 is an optimisation of a market benchmark recognised by independent bodies. The first generation of this successful luminaire has enabled thousands of towns and cities to improve lighting levels, generate energy savings and reduce their ecological footprint.

Thanks to its broad range of lumen packages, its impressive scope of light distributions and its various control options, TECEO GEN2 provides the ideal solution for lighting numerous environments; from bike paths, squares and car parks to residential streets, urban roads, large avenues and motorways.

Designed for a versatile mounting with the same universal piece allowing both side-entry and post-top fixation on a spigot, TECEO GEN2 is easy to combine with standard poles, refined brackets or wall brackets.

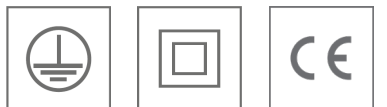

Concept

TECEO GEN2 is composed of three different parts in aluminium, with a top opening. The hinges of the top cover open 120° to provide access to the gear compartment.

TECEO GEN2 can be fitted with LensoFlex® and HiFlex photometric engines, protected by a tempered glass.

The TECEO GEN2 range offers optimised photometrical performance with a minimum total cost of ownership. It takes advantage of the latest photometric innovations. The LensoFlex® and HiFlex platforms offer flexible, energy-efficient photometric solutions that can be tailored to meet the specific lighting needs of any project while maximising savings and providing a quick return on investment.

This highly efficient luminaire is available in three sizes to offer towns and cities the ideal tool to improve lighting levels, generate energy savings and reduce their ecological footprint.

TECEO S has been designed for low-height applications such as residential streets, car parks and bike paths. The TECEO GEN2 1 is ideally suited to lighting urban roads and squares, while the TECEO GEN2 2 is perfect for large roads, avenues and motorways.

The complete range is available with three different universal fixation parts adapted for post-top and side-entry mounting on various spigots (Ø32mm with adapter, Ø42-48mm, Ø60mm and Ø76mm). A dedicated Ø60mm penetrating spigot is also available. The inclination angle can be adjusted on-site for both post-top (0 to +15°) and side-entry (0 to -15°) configurations.



TECEO GEN2 offers highly efficient photometrical platforms.



To remain as open and interoperable as possible, the TECEO GEN2 is available with both NEMA or Zhaga sockets and complies with the ZD4i standard.



The TECEO GEN2 range offers universal fixations for spigots ranging from Ø32 to Ø76mm. It is also available with a dedicated Ø60mm penetrating spigot.



The inclination angle can be adjusted on-site for both post-top (0 to +15°) and side-entry (0 to -15°) configurations.

TYPES OF APPLICATION

- URBAN & RESIDENTIAL STREETS
- BRIDGES
- BIKE & PEDESTRIAN PATHS
- RAILWAY STATIONS & METROS
- CAR PARKS
- SQUARES & PEDESTRIAN AREAS
- ROADS & MOTORWAYS

KEY ADVANTAGES

- 3 sizes to provide the most accurate solutions for numerous road and urban applications
- Maximised savings in energy and maintenance costs
- Dark sky compliant: ULOR = 0%, no up-light
- Universal fixation adapted for side-entry and post-top mounting
- Connected-ready for your future Smart city requirements
- Based on open and interoperable standards
- Compatible with the Schröder EXEDRA control platform
- Zhaga-D4i certified
- High photometric performance
- LensoFlex®4 versatile solutions for high-end photometries maximising comfort and safety
- HiFlex photometric engine designed for optimised energy efficiency



LensoFlex®4

LensoFlex®4 maximises the heritage of the LensoFlex® concept with a very compact yet powerful photometric engine based upon the addition principle of photometric distribution. The number of LEDs in combination with the driving current determines the intensity level of the light distribution. With optimised light distributions and very high efficiency, this fourth generation enables the products to be downsized to meet application requirements with an optimised solution in terms of investment.

LensoFlex®4 optics can feature backlight control to prevent intrusive lighting, or a glare limiter for high visual comfort.

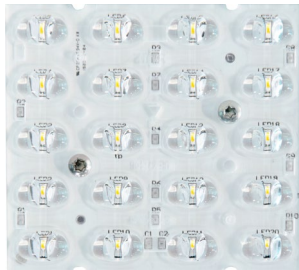

HiFlex™

The HiFlex platform is expertly designed to optimise energy efficiency. Its photometric engines feature high-power LEDs that deliver exceptional performance while consuming minimal energy, resulting in unmatched efficacy (lm/W).

Ideal for projects that require a streamlined approach to maximising lighting efficacy and achieving swift ROI, HiFlex is available in two versions: HiFlex 1, boasting 24 LEDs and HiFlex 2, equipped with 36 LEDs. Both variants are designed with the priorities of compactness, cost-effectiveness and high performance in mind.



Constant Light Output (CLO)

This system compensates for the depreciation of luminous flux to avoid excess lighting at the beginning of the installation's service life. Luminous depreciation over time must be taken into account to ensure a predefined lighting level during the luminaire's useful life.

Without a CLO feature, this simply means increasing the initial power upon installation in order to make up for luminous depreciation. By precisely controlling the luminous flux, the energy needed to reach the required level can be maintained throughout the luminaire's life.

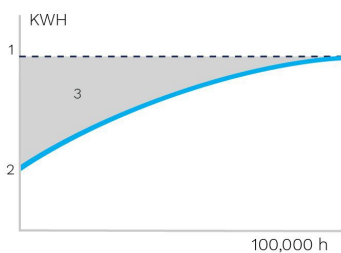

1. Standard lighting level | 2. LED lighting consumption with CLO | 3. Energy savings



Custom dimming profile

Intelligent luminaire drivers can be programmed with complex dimming profiles. Up to five combinations of time intervals and light levels are possible. This feature does not require any extra wiring.

The period between switching on and switching off is used to activate the preset dimming profile. The customised dimming system generates maximum energy savings while respecting the required lighting levels and uniformity throughout the night.

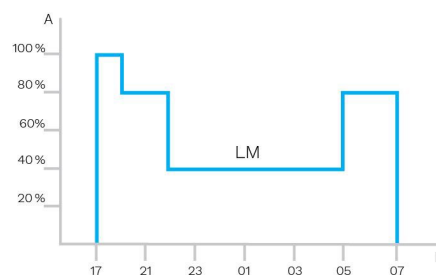

A. Dimming level | B. Time



Daylight sensor / photocell

Photocell or daylight sensors switch the luminaire on as soon natural light falls to a certain level. It can be programmed to switch on during a storm, on a cloudy day (in critical areas) or only at nightfall so as to provide safety and comfort in public spaces.

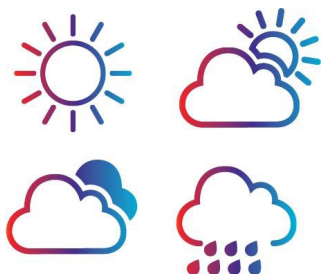

PIR sensor: motion detection

In places with little nocturnal activity, lighting can be dimmed to a minimum most of the time. By using passive infrared (PIR) sensors, the level of light can be raised as soon as a pedestrian or a slow vehicle is detected in the area.

Each luminaire level can be configured individually with several parameters such as minimum and maximum light output, delay period and ON/OFF duration time. PIR sensors can be used in an autonomous or interoperable network.



Schröder EXEDRA is the most advanced lighting management system on the market for controlling, monitoring and analysing streetlights in a user-friendly way.



Standardisation for interoperable ecosystems

Schröder plays a key role in driving standardisation with alliances and partners such as uCIFI, TALQ or Zhaga. Our joint commitment is to provide solutions designed for vertical and horizontal IoT integration. From the body (hardware) to the language (data model) and the intelligence (algorithms), the complete Schröder EXEDRA system relies on shared and open technologies. Schröder EXEDRA also relies on Microsoft Azure for cloud services, provided with the highest levels of trust, transparency, standards conformance and regulatory compliance.

Breaking the silos

With EXEDRA, Schröder has taken a technology-agnostic approach: we rely on open standards and protocols to design an architecture able to interact seamlessly with third-party software and hardware solutions. Schröder EXEDRA is designed to unlock complete interoperability, as it offers the ability to:

- control devices (luminaires) from other brands
- manage controllers and to integrate sensors from other brands
- connect with third-party devices and platforms

A plug-and-play solution

As a gateway-less system using the cellular network, an intelligent automated commissioning process recognises, verifies and retrieves luminaire data into the user interface. The self-healing mesh between luminaire controllers enables real-time adaptive lighting to be configured directly via the user interface. OWLET IV luminaire controllers, optimised for Schröder EXEDRA, operate Schröder's luminaires and luminaires from third parties. They use both cellular and mesh radio networks, optimising geographical coverage and redundancy for continuous operation.

Tailored experience

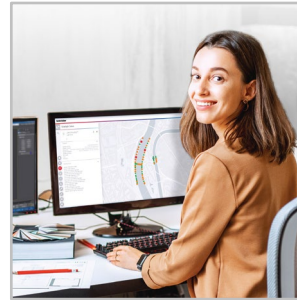

Schröder EXEDRA includes all advanced features needed for smart device management, real-time and scheduled control, dynamic and automated lighting scenarios, maintenance and field operation planning, energy consumption management and third-party connected hardware integration. It is fully configurable and includes tools for user management and multi-tenant policy that enables contractors, utilities or big cities to segregate projects.

A powerful tool for efficiency, rationalisation and decision making

Data is gold. Schröder EXEDRA brings it with all the clarity managers need to drive decisions. The platform collects massive amounts of data from end devices and, aggregates, analyses and intuitively displays them to help end-users take the right actions.

Protected on every side



Schröder EXEDRA provides state-of-the-art data security with encryption, hashing, tokenisation, and key management practices that protect data across the whole system and its associated services. The whole platform is ISO 27001 certified. It demonstrates that Schröder EXEDRA meets the requirements for establishing, implementing, maintaining and continually improving security management.

Mobile App: any time, any place, connect to your street lighting

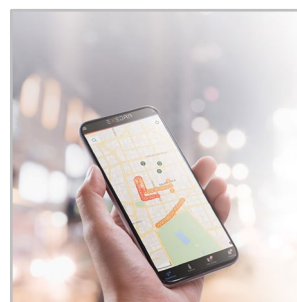

The Schröder EXEDRA mobile application offers the essential functionalities of the desktop platform, to accompany all types of operator on site in their daily effort to maximise the potential of connected lighting. It enables real-time control and settings, and contributes to effective maintenance.

The Zhaga consortium joined forces with the DiiA and produced a single Zhaga-D4i certification that combines the Zhaga Book 18 version 2 outdoor connectivity specifications with the DiiA's D4i specifications for intra-luminaire DALI.

2 sockets: top and bottom

The Zhaga socket is small and suited to applications where aesthetics is essential. The architecture of Zhaga-D4i also foresees the possibility of putting two sockets on one luminaire, allowing for instance, the combination of a detection sensor and a control node. This also has the added value of standardising certain detection sensor communications with the D4i protocol.

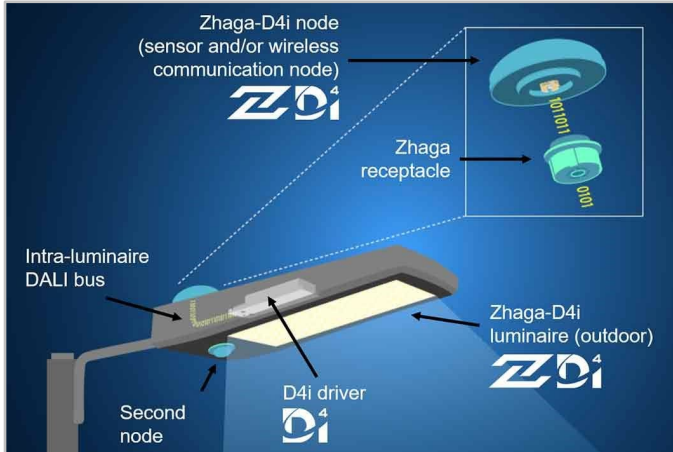

Standardisation for interoperable ecosystems



As a founding member of the Zhaga consortium, Schröder has participated in the creation of, and therefore supports, the Zhaga-D4i certification program and the initiative of this group to standardise an interoperable ecosystem. The D4i specifications take the best of the standard DALI2 protocol and adapt it to an intra-luminaire environment but it has certain limitations. Only luminaire mounted control devices can be combined with a Zhaga-D4i luminaire.

According to the specification, control devices are limited respectively to 2W and 1W average power consumption.

Certification program

The Zhaga-D4i certification covers all the critical features including mechanical fit, digital communication, data reporting and power requirements within a single luminaire, ensuring plug-and-play interoperability of luminaires (drivers) and peripherals such as connectivity nodes.

Cost-effective solution

A Zhaga-D4i certified luminaire includes drivers offering features that had previously been in the control node, like energy metering, which has in turn simplified the control device therefore reducing the price of the control system.

With the PureNight concept, Schröder offers the ultimate solution for restoring the night sky without switching off cities, while maintaining safety and well-being for people and preserving wildlife. The PureNight concept guarantees that your Schröder lighting solution satisfies environmental laws and requirements. Well-designed LED lighting has the potential to improve the environment in all respects.

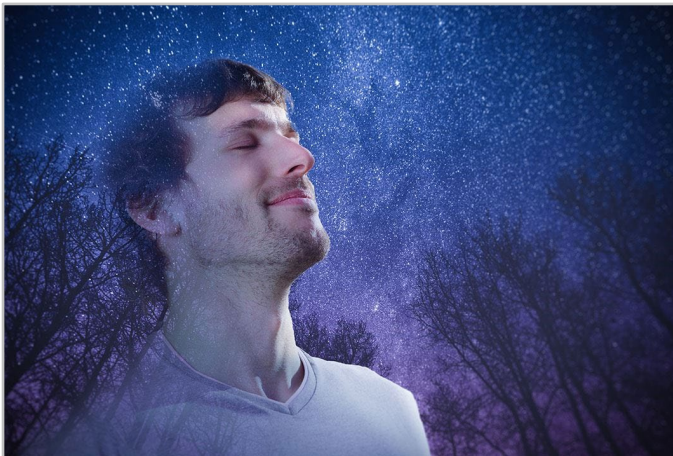

Direct the light only where it is wanted and needed

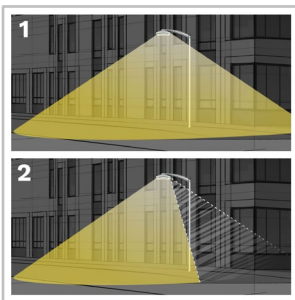

1. Without backlight
2. With backlight

Schröder is renowned for its expertise in photometry. Our optics direct light only where it is wanted and needed. However, light trespass behind the luminaire might be a key concern when it comes to protecting a sensitive wildlife habitat or avoiding intrusive lighting towards buildings. Our fully integrated backlight solutions easily address this potential risk.

Offer maximum visual comfort to people

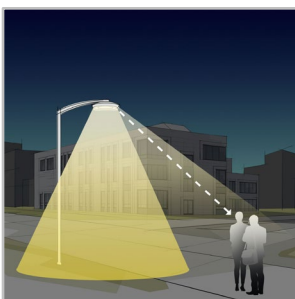

Because of the lower installation height compared to road lighting, visual comfort is an essential aspect of urban lighting. Schröder designs lenses and accessories to minimise any type of glare (distracting, discomforting, disabling glare and blinding glare). Our design offices harness a range of possibilities to find the best solutions for each project and ensure that we provide a gentle light that delivers the best night-time experience.

Protect wildlife

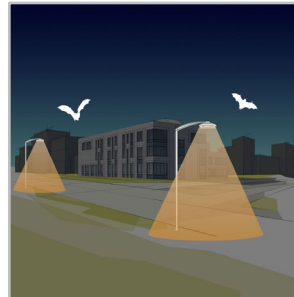

If not well designed, artificial lighting can badly affect wildlife. Blue light and excessive intensity can have a damaging effect on all types of life. Blue light radiation has the ability to suppress the production of melatonin, the hormone that contributes to the regulation of the circadian rhythm. It can also alter the behavioural patterns of animals including bats and moths, as it can change their movements towards or away from light sources. Schröder favours warm white LEDs with minimal blue light, combined with advanced control systems including sensors. This enables permanent adaptation of the lighting to the real needs of the moment, minimising disturbance to the fauna and flora.

Choose a Dark Sky certified luminaire



The International Dark-Sky Association (IDA) is the recognised authority on light pollution. It provides leadership, tools and resources to industries and companies willing to reduce light pollution. The IDA's Fixture Seal of Approval programme certifies outdoor lighting fixtures as being Dark Sky Friendly. All products approved by this programme must comply with the following criteria:

- The light sources shall have a maximum correlated colour temperature of 3000K;
- Uplight allowance limited to 0.5% of total output, or 50 lumens, with no more than 10 lumens in the 90-100 degree UL zone;
- The luminaires must have a dimming capability to 10% of full rating;
- The luminaires must be equipped with a fixed mounting option;
- The luminaires must have Safety Certification by an independent laboratory.

This approved Schröder range of luminaires complies with these requirements.

GENERAL INFORMATION

Recommended installation height	4m to 15m 13' to 49'
Circle Light label	Score ≥90 - The product fully meets circular economy requirements
Driver included	Yes
CE mark	Yes
CB mark	Yes
ENEC certified	Yes
ENEC+ certified	Yes
UL certified	Yes
ROHS compliant	Yes
Dark Sky friendly lighting (IDA certification)	Yes
Zhaga-D4i certified	Yes
French law of December 27th 2018 - Compliant with application type(s)	a, b, c, d, e, f, g
BE 005 certified	Yes
RCM mark	Yes
UKCA marking	Yes
Testing standard	EN 60598-1 EN 60598-2-3:2003/A1:2011 UL 1598 CSA C22.2 No. 250.0 ANSI C 136-31

HOUSING AND FINISH

Housing	Aluminium
Optic	PMMA
Protector	Tempered glass
Housing finish	Polyester powder coating
Standard colour(s)	AKZO grey 900 sanded
Tightness level	IP 66
Impact resistance	IK 08, IK 09, IK 10
Vibration test	Compliant with ANSI 1.5G and 3G and modified IEC 68-2-6 (0.5G)
Access for maintenance	By loosening screws on the top cover Tool-less access to gear compartment (option)

· Any other RAL or AKZO colour upon request

OPERATING CONDITIONS

Operating temperature range (Ta)	-40°C up to +55°C / -40°F up to 131°F with wind effect
----------------------------------	--------------------------------------------------------

· Depending on the luminaire configuration. For more details, please contact us.

ELECTRICAL INFORMATION

Electrical class	Class 1 US, Class I EU, Class II EU
Nominal voltage	120-277V – 50-60Hz 220-240V – 50-60Hz 347V – 50-60Hz
Surge protection options (kV)	6 10
Electromagnetic compatibility (EMC)	EN 55015 / EN 61000-3-2 / EN 61000-4-5 / EN 61547
Control protocol(s)	1-10V, DALI
Control options	AmpDim, Bi-power, Custom dimming profile, Photocell, Remote management
Socket	Zhaga (optional) NEMA 7-pin (optional)
Associated control system(s)	Schröder EXEDRA
Sensor	PIR (optional)

OPTICAL INFORMATION

LED colour temperature	2200K (Warm White WW 722) 2700K (Warm White WW 727) 3000K (Warm White WW 730) 3000K (Warm White WW 830) 4000K (Neutral White NW 740) 5700K (Cool White CW 757)
Colour rendering index (CRI)	>70 (Warm White WW 722) >70 (Warm White WW 727) >70 (Warm White WW 730) >80 (Warm White WW 830) >70 (Neutral White NW 740) >70 (Cool White CW 757)
ULOR	0%
ULR	0%

- Meets IDA Dark Sky requirements when fitted with LEDs of 3000K or less.
- ULOR may be different according to the configuration. Please consult us.
- ULR may be different according to the configuration. Please consult us.

LIFETIME OF THE LEDS @ TQ 25°C

All configurations	100,000h - L95
--------------------	----------------

· Lifetime may be different according to the size/configurations. Please consult us.

DIMENSIONS AND MOUNTING

AxBxC (mm inch)	TECEO S : 450x99x252 17.7x3.9x9.9 TECEO GEN2 1 : 580x107x310 22.8x4.2x12.2 TECEO GEN2 2 : 740x118x427 29.1x4.6x16.8
Weight (kg lbs)	TECEO S : 5.1 11.2 TECEO GEN2 1 : 7.9 17.4 TECEO GEN2 2 : 14.2 31.2
Aerodynamic resistance (CxS)	TECEO S : 0.05 TECEO GEN2 1 : 0.06 TECEO GEN2 2 : 0.08
Mounting possibilities	Side-entry slip-over – Ø32mm Side-entry slip-over – Ø42mm Side-entry slip-over – Ø48mm Side-entry slip-over – Ø60mm Side-entry slip-over – Ø76mm Side-entry penetrating – Ø60mm Post-top slip-over – Ø32mm Post-top slip-over – Ø42mm Post-top slip-over – Ø48mm Post-top slip-over – Ø60mm Post-top slip-over – Ø76mm Post-top penetrating – Ø60mm

· Size and weight may be different according to the configuration. Please consult us for more information.

· To meet International Dark Sky requirements, a fixed mount must be selected (+/- 15° allowable to permit leveling so that the luminaire is parallel to the road [0° final tilt]).

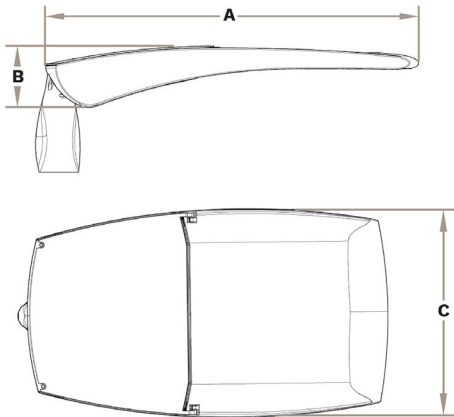

TECEO GEN2 | TECEO GEN2 1 and TECEO GEN2 2 - Slip-over mounting for Ø48mm spigot - 2xM10 screws

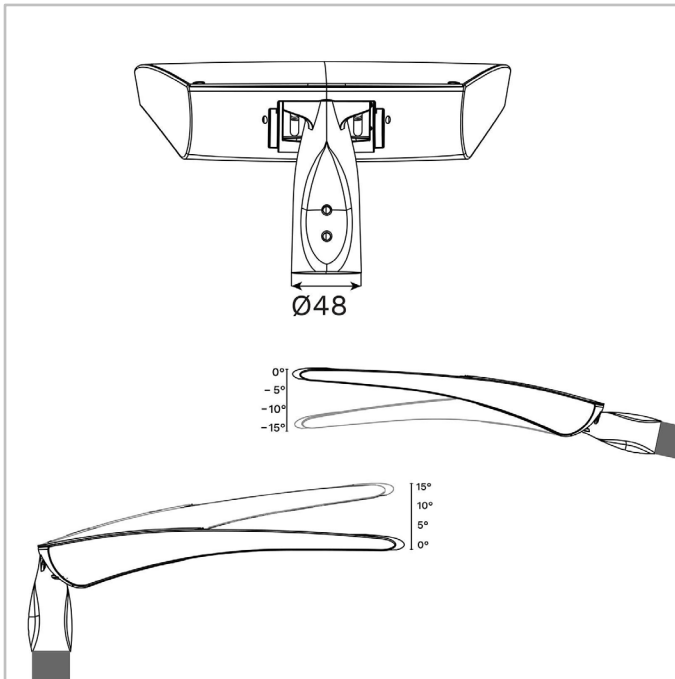

TECEO GEN2 | TECEO GEN2 1 and TECEO GEN2 2 - Slip-over mounting for Ø76mm spigot - 2xM10 screws

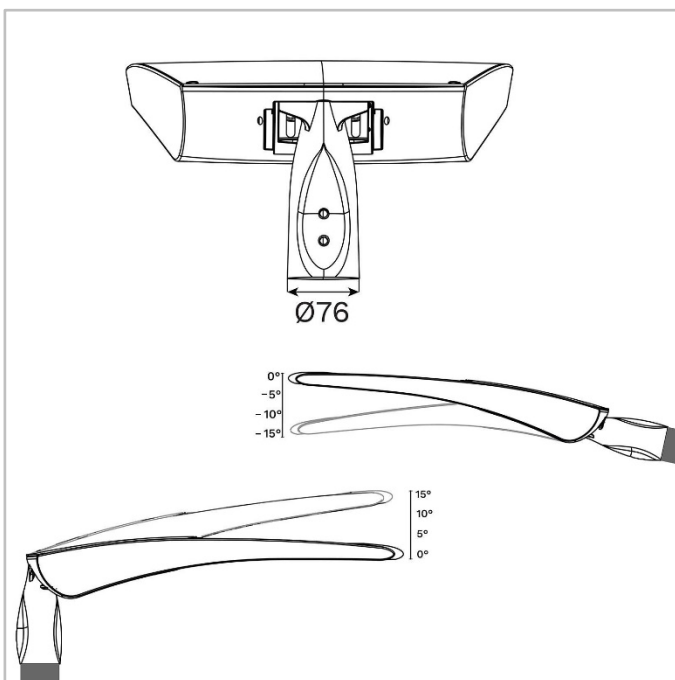

TECEO GEN2 | TECEO GEN2 1 and TECEO GEN2 2 - Slip-over mounting for Ø60mm spigot - 2xM10 screws

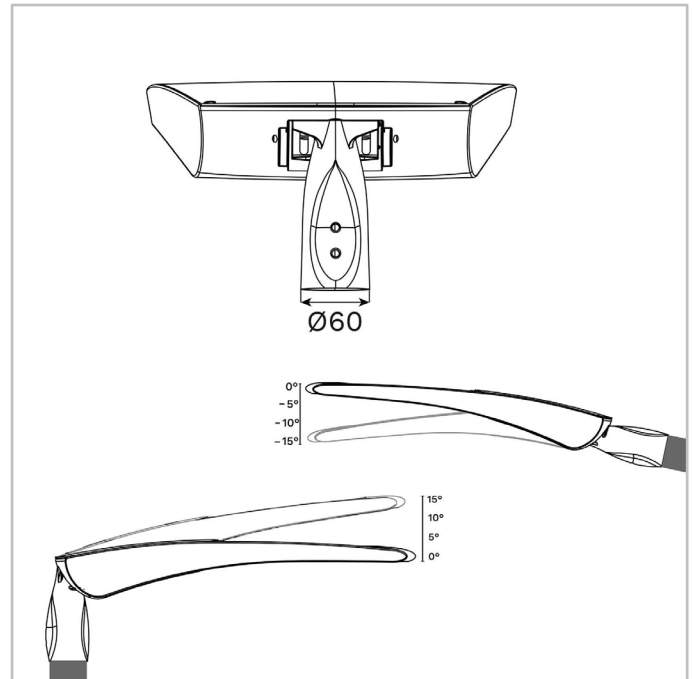

TECEO GEN2 | TECEO S - Slip-over mountings for Ø32 (with adapter), Ø42-48mm, Ø60mm or Ø76mm spigots - 2xM10 screws

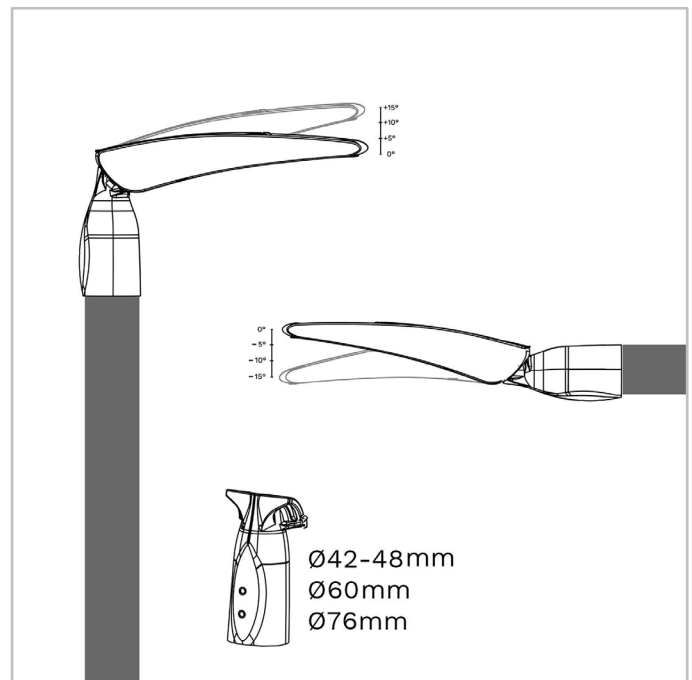

TECEO GEN2 | TECEO S, TECEO GEN2 1 and
TECEO GEN2 2 - penetrating mounting for
Ø60mm spigots - 2xM8 screws

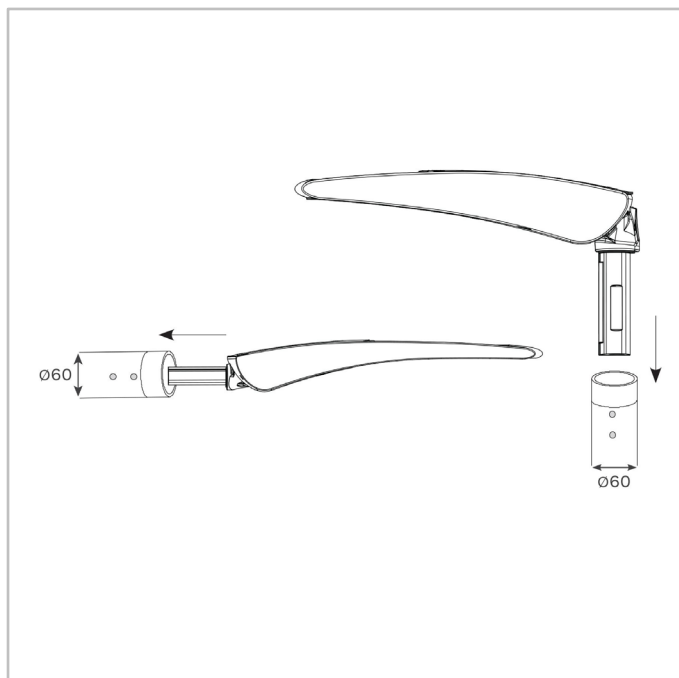

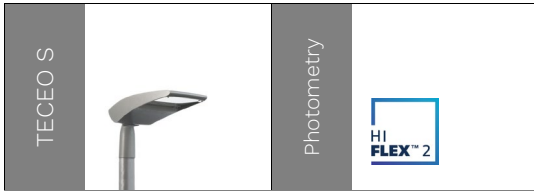

Number of LEDs	Luminaire output flux (lm)								Power consumption (W)		Luminaire efficacy (lm/W)
	Warm White WW 722		Warm White WW 727		Warm White WW 730		Neutral White NW 740				
	Min	Max	Min	Max	Min	Max	Min	Max	Min	Max	Up to
24	1200	6000	1300	6800	1400	7100	1500	7600	11	52	161
36	1800	7600	2000	8600	2100	9000	2200	9700	15	60	173

Tolerance on LED flux is $\pm 7\%$ and on total luminaire power $\pm 5\%$

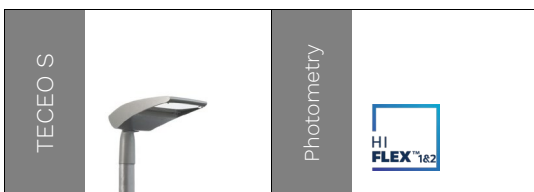

Number of LEDs	Luminaire output flux (lm)								Power consumption (W)		Luminaire efficacy (lm/W)
	Warm White WW 722		Warm White WW 727		Warm White WW 730		Neutral White NW 740				
	Min	Max	Min	Max	Min	Max	Min	Max	Min	Max	Up to
24	1200	6000	1300	6800	1400	7100	1500	7600	11	52	161
36	1800	7600	2000	8600	2100	9000	2200	9700	15	60	173

Tolerance on LED flux is $\pm 7\%$ and on total luminaire power $\pm 5\%$

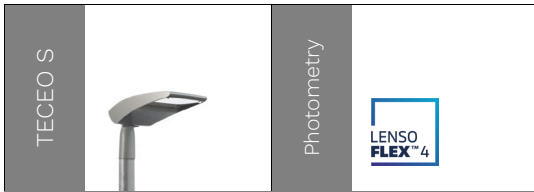

Number of LEDs	Luminaire output flux (lm)												Power consumption (W)		Luminaire efficacy (lm/W)
	Warm White WW 722		Warm White WW 727		Warm White WW 730		Warm White WW 830		Neutral White NW 740		Cool White CW 757				
	Min	Max	Min	Max	Min	Max	Min	Max	Min	Max	Min	Max	Min	Max	Up to
10	400	3200	400	3600	500	3900	400	3600	500	4200	500	4000	7	35	156
20	800	6500	900	7300	1000	7800	900	7300	1100	8500	1000	8100	13	66	165
25	1900	7700	2100	8600	2300	9300	2100	8600	2500	10000	2300	9600	16	77	171

Tolerance on LED flux is ± 7% and on total luminaire power ± 5 %

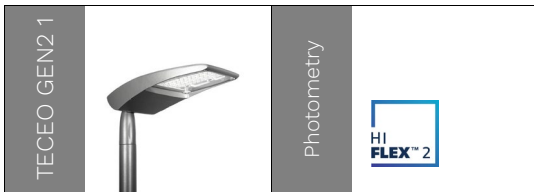

Number of LEDs	Luminaire output flux (lm)								Power consumption (W)		Luminaire efficacy (lm/W)
	Warm White WW 722		Warm White WW 727		Warm White WW 730		Neutral White NW 740				
	Min	Max	Min	Max	Min	Max	Min	Max	Min	Max	Up to
48	2400	12100	2800	13600	2900	14200	3100	15300	19	99	174
72	3600	14000	4000	15800	4200	16400	4500	17600	29	105	176

Tolerance on LED flux is ± 7% and on total luminaire power ± 5 %

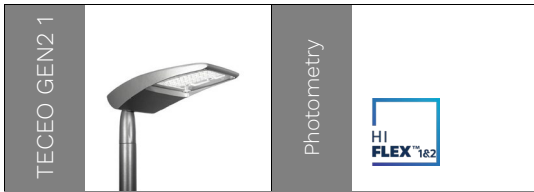

Number of LEDs	Luminaire output flux (lm)								Power consumption (W)		Luminaire efficacy (lm/W)
	Warm White WW 722		Warm White WW 727		Warm White WW 730		Neutral White NW 740				
	Min	Max	Min	Max	Min	Max	Min	Max	Min	Max	Up to
48	2400	12100	2800	13600	2900	14200	3100	15300	19	99	174
72	3600	14000	4000	15800	4200	16400	4500	17600	29	105	176

Tolerance on LED flux is ± 7% and on total luminaire power ± 5 %

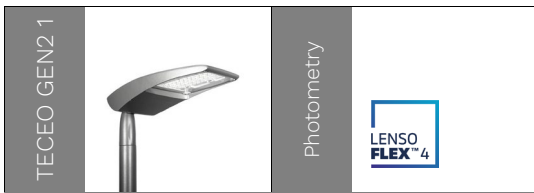

Number of LEDs	Luminaire output flux (lm)												Power consumption (W)		Luminaire efficacy (lm/W)
	Warm White WW 722		Warm White WW 727		Warm White WW 730		Warm White WW 830		Neutral White NW 740		Cool White CW 757				
	Min	Max	Min	Max	Min	Max	Min	Max	Min	Max	Min	Max	Min	Max	Up to
20	800	6400	900	7200	1000	7700	900	7200	1100	8400	1000	8000	13	66	165
25	1900	7500	2100	8400	2200	9000	2100	8400	2400	9800	2300	9300	16	77	166
30	1200	9700	1400	10800	1500	11600	1400	10800	1600	12600	1500	12000	19	96	175
40	1700	12900	1900	14400	2000	15500	1900	14400	2200	16800	2100	16000	24	130	179
50	3800	15000	4200	16800	4500	18100	4200	16800	4900	19600	4700	18700	30	152	174

Tolerance on LED flux is ± 7% and on total luminaire power ± 5 %



Number of LEDs	Luminaire output flux (lm)								Power consumption (W)		Luminaire efficacy (lm/W)
	Warm White WW 722		Warm White WW 727		Warm White WW 730		Neutral White NW 740				
	Min	Max	Min	Max	Min	Max	Min	Max	Min	Max	
72	3700	17600	4200	19900	4400	20700	4700	22300	29	148	168
96	5000	23400	5700	26500	5900	27500	6400	29600	39	198	169
108	5400	19800	6200	22400	6400	23300	6900	25100	43	153	175
144	7300	26100	8300	29500	8600	30600	9300	33000	58	202	174
216	11100	28600	12600	32300	13100	33600	14100	36100	86	210	177

Tolerance on LED flux is ± 7% and on total luminaire power ± 5 %



Number of LEDs	Luminaire output flux (lm)								Power consumption (W)		Luminaire efficacy (lm/W)
	Warm White WW 722		Warm White WW 727		Warm White WW 730		Neutral White NW 740				
	Min	Max	Min	Max	Min	Max	Min	Max	Min	Max	
72	3700	17600	4200	19900	4400	20700	4700	22300	29	148	168
96	5000	23400	5700	26500	5900	27500	6400	29600	39	198	169
108	5400	19800	6200	22400	6400	23300	6900	25100	43	153	175
144	7300	26100	8300	29500	8600	30600	9300	33000	58	202	174
216	11100	28600	12600	32300	13100	33600	14100	36100	86	210	177

Tolerance on LED flux is ± 7% and on total luminaire power ± 5 %

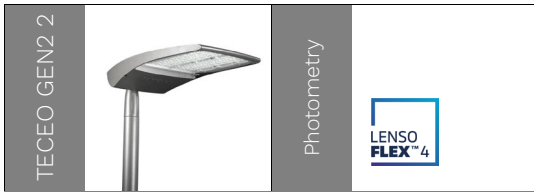

Number of LEDs	Luminaire output flux (lm)												Power consumption (W)		Luminaire efficacy (lm/W)
	Warm White WW 722		Warm White WW 727		Warm White WW 730		Warm White WW 830		Neutral White NW 740		Cool White CW 757				
	Min	Max	Min	Max	Min	Max	Min	Max	Min	Max	Min	Max	Min	Max	
50	2100	15300	2300	17100	2500	18400	2300	17100	2700	19900	2600	19000	30	159	182
60	2500	16900	2800	18900	3000	20300	2800	18900	3300	21900	3100	20900	35	163	184
75	5700	17400	6400	19500	6900	21000	6400	19500	7400	22700	7100	21600	44	160	174
80	3400	22500	3800	25200	4100	27100	3800	25200	4400	29300	4200	27900	46	218	187
100	4200	27300	4700	30500	5100	32800	4700	30500	5500	35400	5200	33800	58	268	187
120	5100	30000	5700	33600	6100	36100	5700	33600	6600	39000	6300	37300	71	280	184
150	11500	34200	12900	38300	13900	41200	12900	38300	15000	44500	14300	42500	88	320	175

Tolerance on LED flux is $\pm 7\%$ and on total luminaire power $\pm 5\%$

