

SCULPLINE



Designer : Voxdale



Flexible wall washer for advanced architectural illumination

SCULPLINE is a modern floodlight offering a wall washer effect that can be used for façade or monument illumination.

It enables lighting designers to sculpt the light to create a unique identity for monuments and buildings.

SCULPLINE creates a warm ambiance while providing huge energy savings thanks to its performing LensoFlex®2 photometric engine. It offers a wide palette of colours and lighting effects.

SCULPLINE is dedicated to creating striking lighting effects and enhance the value of architectural buildings at night. Through control systems, dynamic lighting scenarios can be achieved for dramatic results.



Concept

SCULPLINE is composed of an extruded aluminium body, polycarbonate end caps, glass or polycarbonate protector with customizable (paintable) cover plate.

It is available with symmetrical and asymmetrical light distributions, monochromatic, RGBW or tunable white LEDs and can be dynamically controlled using the DMX-RDM or DALI control to achieve the desired effect.

SCULPLINE can be installed in a continuous line by placing several modules one after the other to achieve excellently uniformity. Different light diffusers are available providing maximum flexibility. The power supply can be located in a central cabinet to minimise the impact on the façade.

Various types of brackets are available for a flexible mounting: standard compact brackets, wall-mounted extension arms, end clamps and side clamps.

SCULPLINE is available in two lengths (0.5m or 1m) to offer flexible solutions that cope with project constraints.



Monochromatic, RGBW and tunable white LEDs are available for SCULPLINE.



SCULPLINE offers symmetrical and asymmetrical photometric light distributions.

TYPES OF APPLICATION

- ACCENT & ARCHITECTURAL
- BRIDGES

KEY ADVANTAGES

- Elegant and compact design for minimum impact on architecture
- Front cover can be customised to perfectly integrate the environment
- Broad palette of colours and lighting effects/distributions
- Numerous (symmetrical and asymmetrical) light distributions
- Variable number of LEDs from 10 up to 48 LEDs/m
- Large range of mounting options
- Low energy consumption



The connections can be made without the need for stripping or special tools.



The inclination angle of the SCULPLINE is indicated on bracket.



LensoFlex®2

LensoFlex®2 is based upon the addition principle of photometric distribution. Each LED is associated with a specific PMMA lens that generates the complete photometric distribution of the luminaire. The number of LEDs in combination with the driving current determines the intensity level of the light distribution.



GENERAL INFORMATION

CE mark	Yes
ROHS compliant	Yes
French law of December 27th 2018 - Compliant with application type(s)	a, b, c, d, e, f, g
Testing standard	LM 79-08 (all measurements in ISO17025 accredited laboratory)

HOUSING AND FINISH

Housing	Aluminium Composite materials
Optic	Polycarbonate
Protector	Tempered glass Polycarbonate
Tightness level	IP 66
Impact resistance	IK 07, IK 08

· IK may be different according to the size/configurations. Please consult us.

OPERATING CONDITIONS

Operating temperature range (Ta)	-20°C up to +50°C / -4°F up to 122°F
----------------------------------	--------------------------------------

· Depending on the luminaire configuration. For more details, please contact us.

ELECTRICAL INFORMATION

Electrical class	Class I EU, Class II EU
Nominal voltage	220-240V – 50-60Hz
Surge protection options (kV)	10
Electromagnetic compatibility (EMC)	EN 55015 / EN 61547
Control protocol(s)	DALI, DMX-RDM
Control options	Remote management
Associated control system(s)	Nicolaudie Pharos

OPTICAL INFORMATION

LED colour temperature	RGB CW 3000K (Warm White 830) 4000K (Neutral White 740) 4000K (Neutral White 840)
Colour rendering index (CRI)	>80 (Warm White 830) >70 (Neutral White 740) >80 (Neutral White 840)

LIFETIME OF THE LEDS @ TQ 25°C

All configurations	100,000h - L90
--------------------	----------------

DIMENSIONS AND MOUNTING

AxBxC (mm inch)	SCULPLINE 1 - 93x97x500 3.7x3.8x19.7 SCULPLINE 2 - 93x97x1000 3.7x3.8x39.4
Weight (kg lbs)	SCULPLINE 1 - 4.8 10.6 SCULPLINE 2 - 6.4 14.1
Mounting possibilities	Bracket enabling adjustable inclination

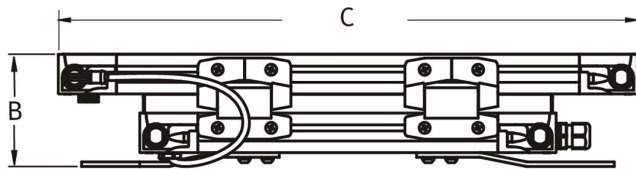
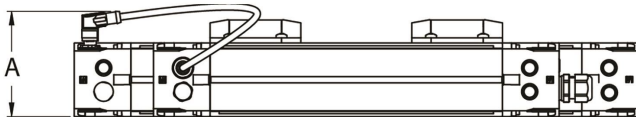

SCULPLINE | Rotule - available with end clamps and lateral clamps

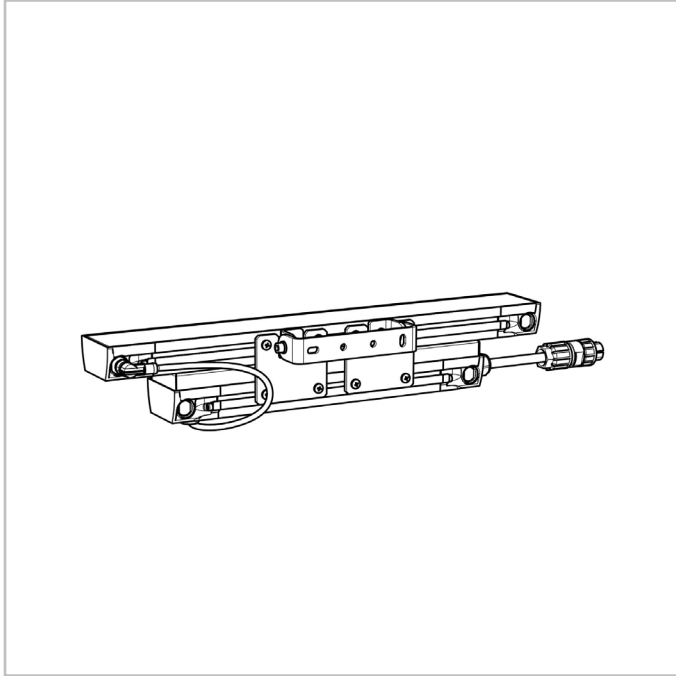



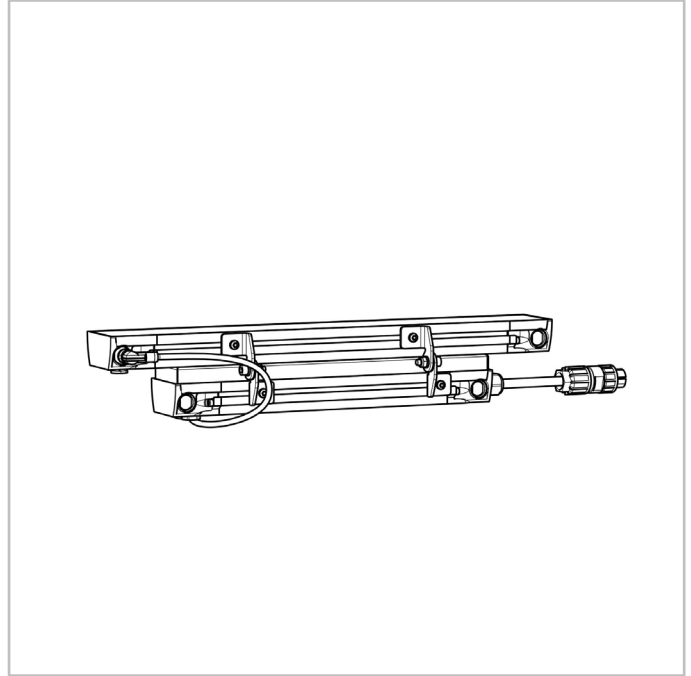

SCULPLINE | Tilting bracket - available with end clamps and lateral clamps

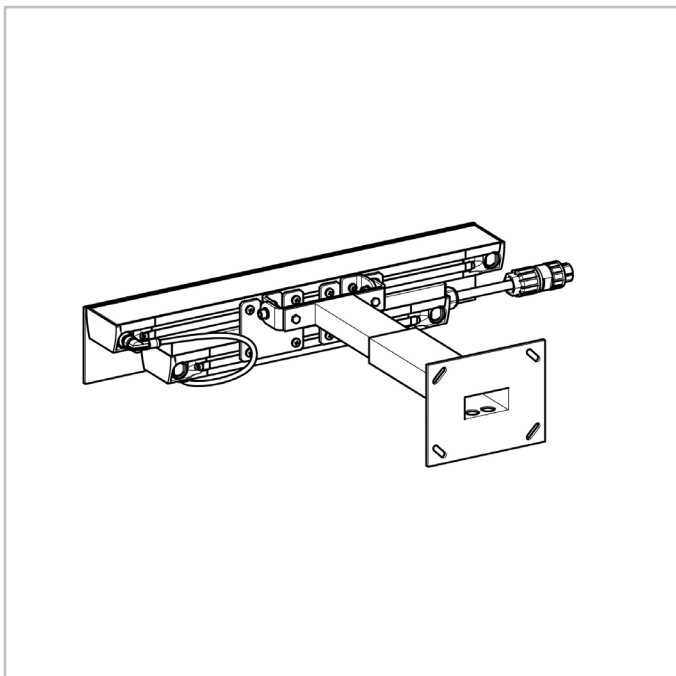

SCULPLINE | Expandable bracket with knuckle joint





Luminaire	Number of LEDs	mA	Luminaire output flux (lm) Warm White 830		Luminaire output flux (lm) Neutral White 840		Luminaire output flux (lm) RGB CW		Luminaire output flux (lm) Neutral White 740		W	lm/W	Photometry
			Min	Max	Min	Max	Min	Max	Min	Max			
SCULPLINE 1	5	700	500	900	500	1000	-	-	-	-	13.6	74	
	20	350	1200	2300	1300	2500	-	-	-	-	25	100	
	20	350	-	-	-	-	1100	1600	-	-	25	64	
	20	660	1900	3000	2000	3200	-	-	-	-	44.5	72	
	24	350	2600	2900	-	-	-	-	3000	3300	28	118	
	24	590	3900	4300	-	-	-	-	4500	5000	45	111	
SCULPLINE 2	10	700	1000	1900	1100	2000	-	-	-	-	24.9	80	
	40	350	2500	4700	2600	5000	-	-	-	-	47	106	
	40	350	-	-	-	-	2300	3200	-	-	50	64	
	40	660	3900	7500	4200	8000	-	-	-	-	89	90	
	48	350	5300	5800	-	-	-	-	6100	6700	54	124	
	48	590	7900	8700	-	-	-	-	9100	10000	90	111	

Tolerance on LED flux is $\pm 7\%$ and on total luminaire power $\pm 5\%$

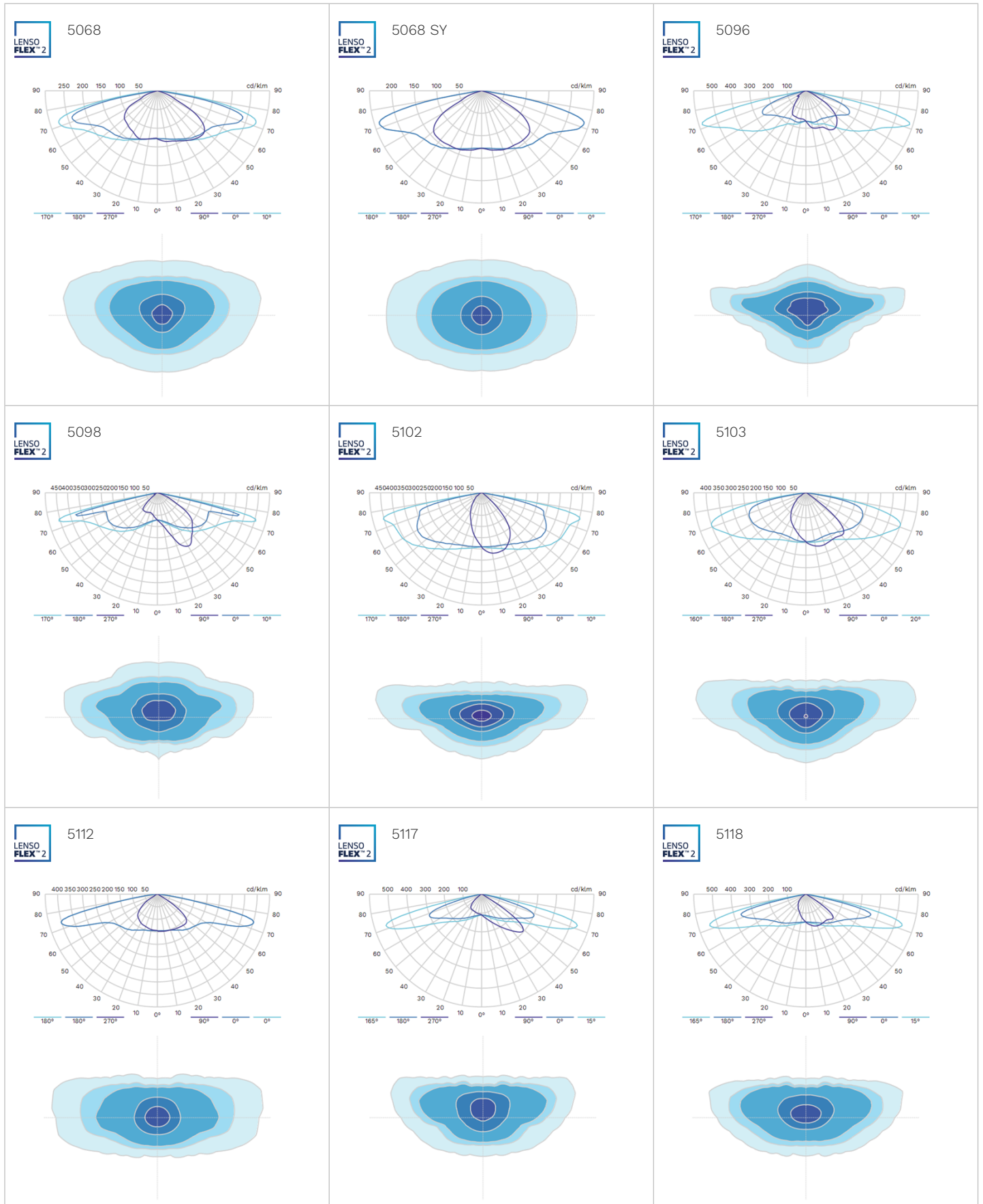

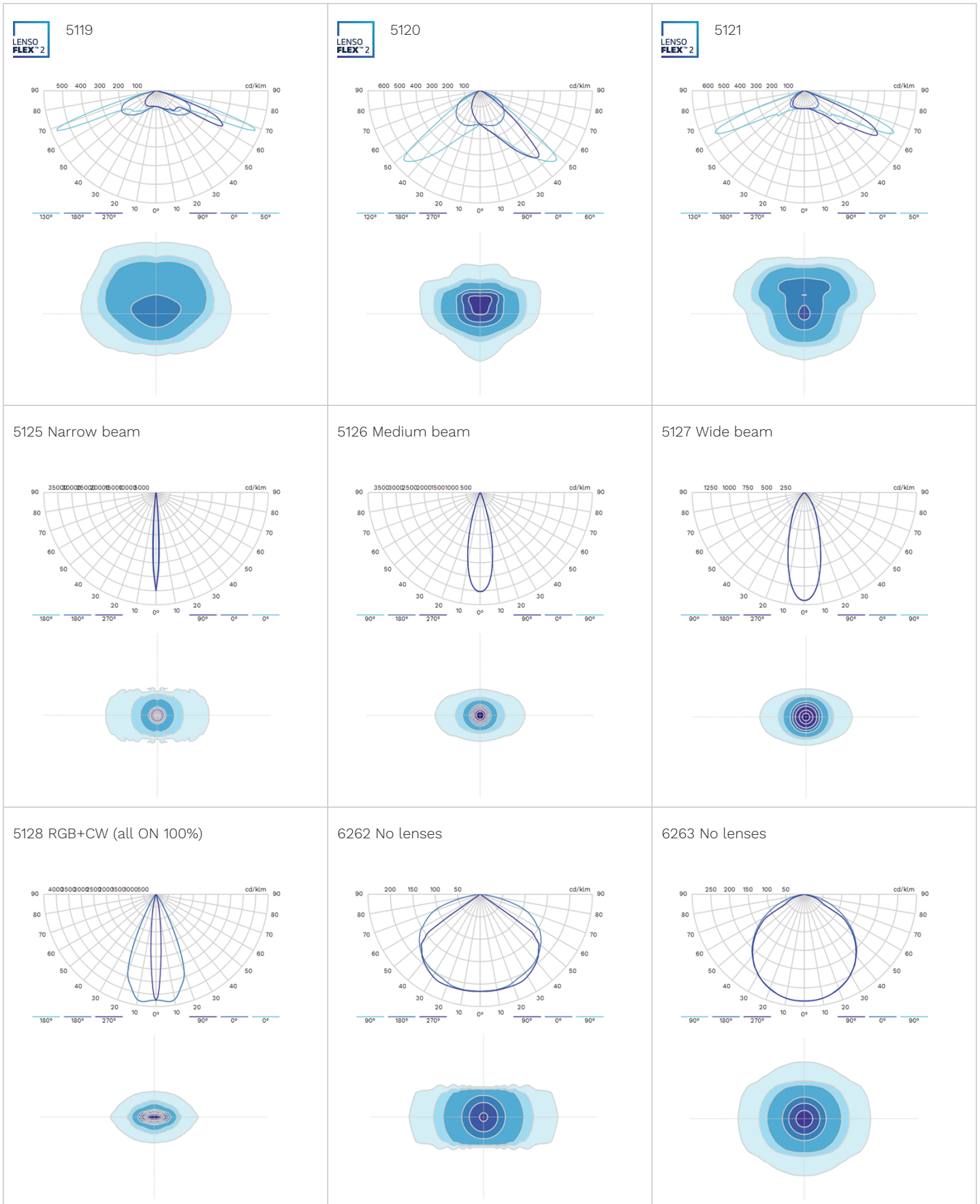

6286 - Diffuser P25 striated

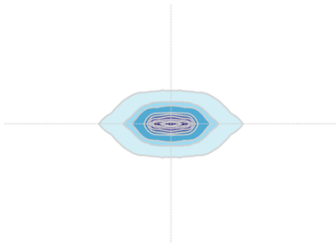
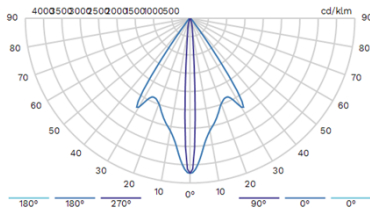

6287 - Diffuser sanded

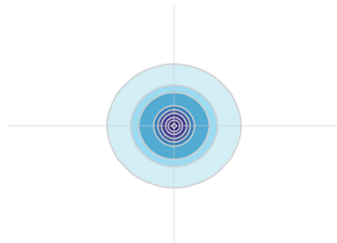
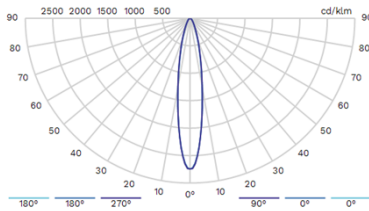

6288 - Diffuser P42 prismatic

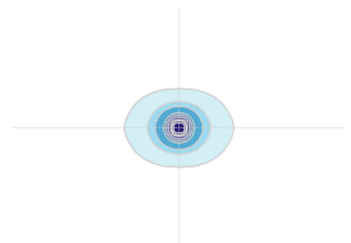
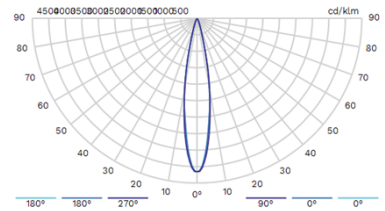

6289 - Diffuser P25 striated

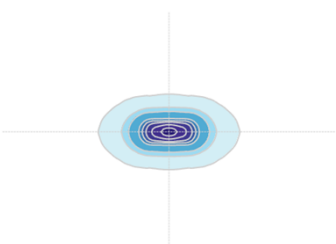
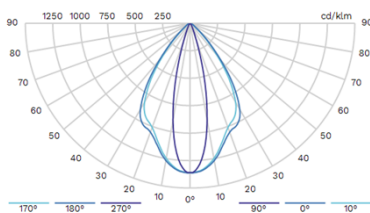

6290 - Diffuser P25 striated

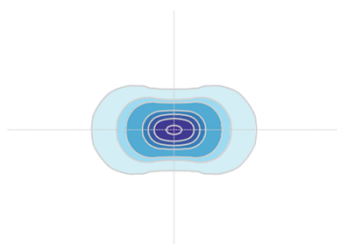
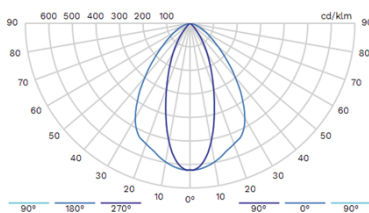

6291 - Diffuser P25 striated

